









Part List







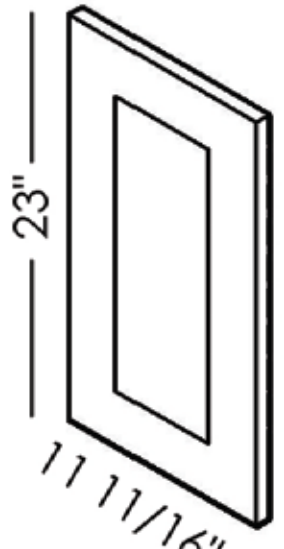
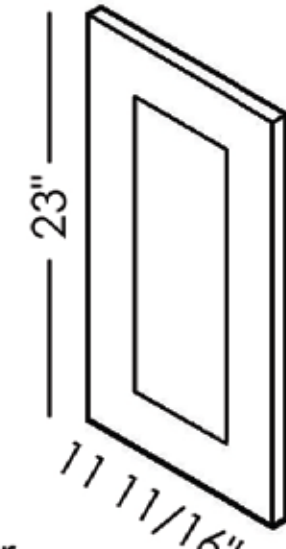
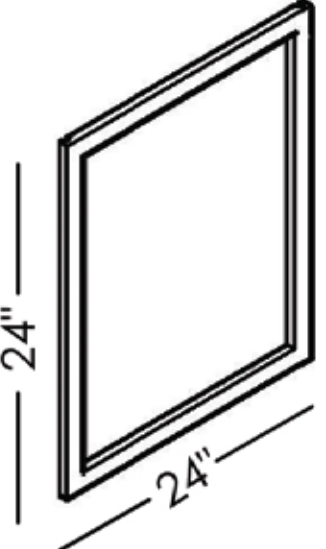
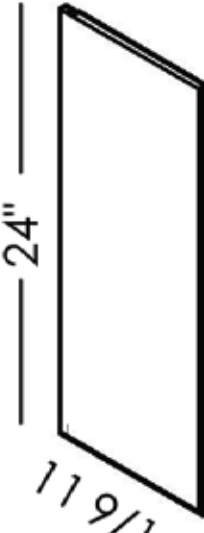
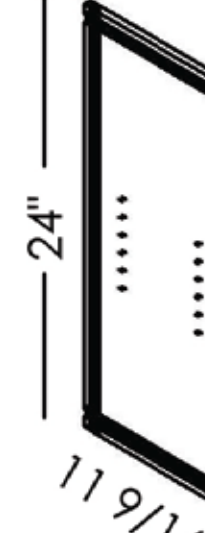
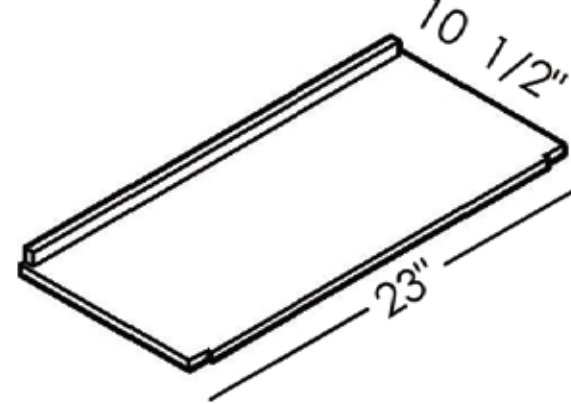
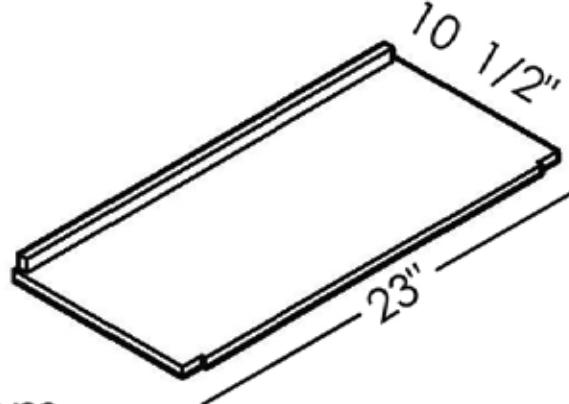
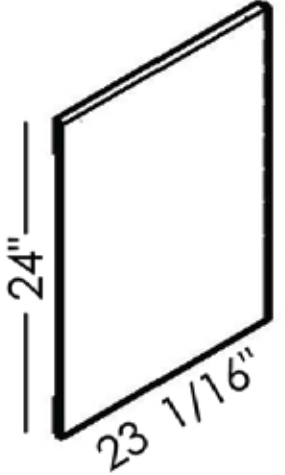
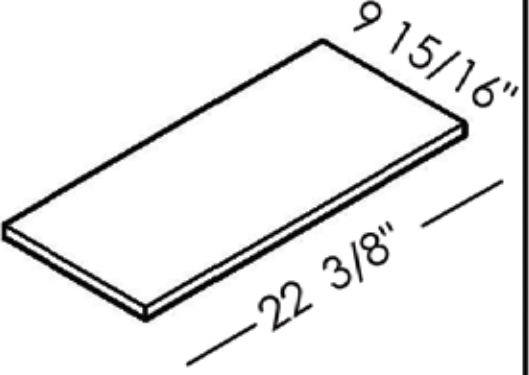
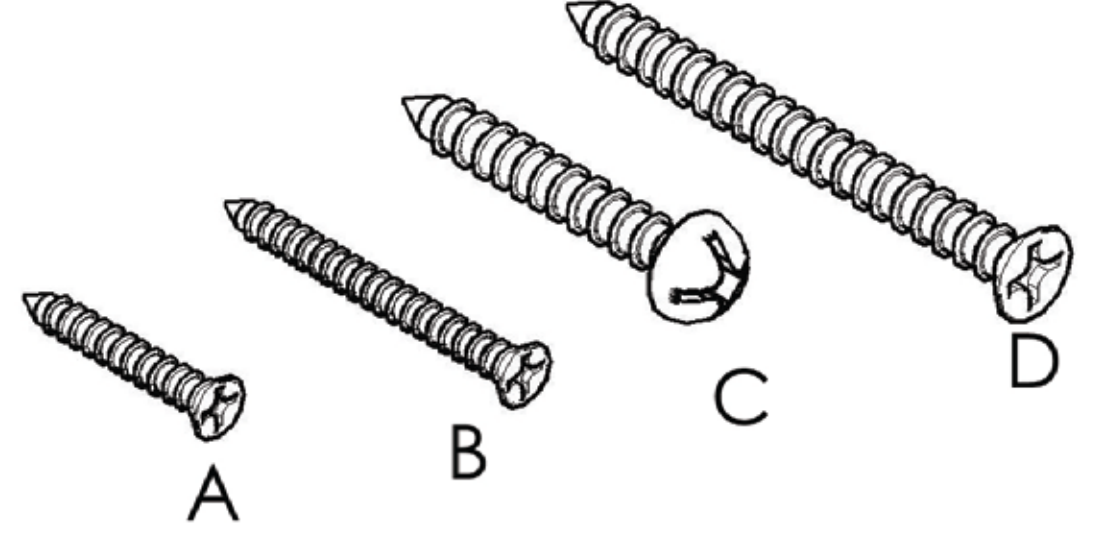

W2424

Unit: inch

No	Picture	Specification	Qty
A		Screw $\text{Ø}3 \times 1/2$ "	32
B		Screw $\text{Ø}3 \times 5/8$ "	8
C		Screw $\text{Ø}4 \times 5/8$ "	4
D		Screw $\text{Ø}4 \times 1 \frac{3}{16}$ "	6
E		Corner Bracket	8
F		Shelf Clip	4
G		Hinges	4
H		Bumper	4

<p>1</p>  <p>Left Door</p>	<p>2</p>  <p>Right Door</p>	<p>3</p>  <p>Face Frame</p>
<p>4</p>  <p>Left Side Panel</p>	<p>5</p>  <p>Right Side Panel</p>	<p>6</p>  <p>Top Panel</p>
<p>7</p>  <p>Bottom Panel</p>	<p>8</p>  <p>Back Panel</p>	<p>9</p>  <p>Shelf</p>
 <p>A B C D</p>		

Assembly instructions

No	Picture	Specification	Qty	No	Picture	Specification	Qty
A		Screw $\varnothing 3 \times 1/2$ "	32	E		Corner Bracket	8
B		Screw $\varnothing 3 \times 5/8$ "	8	F		Shelf Clip	4
C		Screw $\varnothing 4 \times 5/8$ "	4	G		Hinges	4
D		Screw $\varnothing 4 \times 1 \frac{3}{16}$ "	6	H		Bumper	4

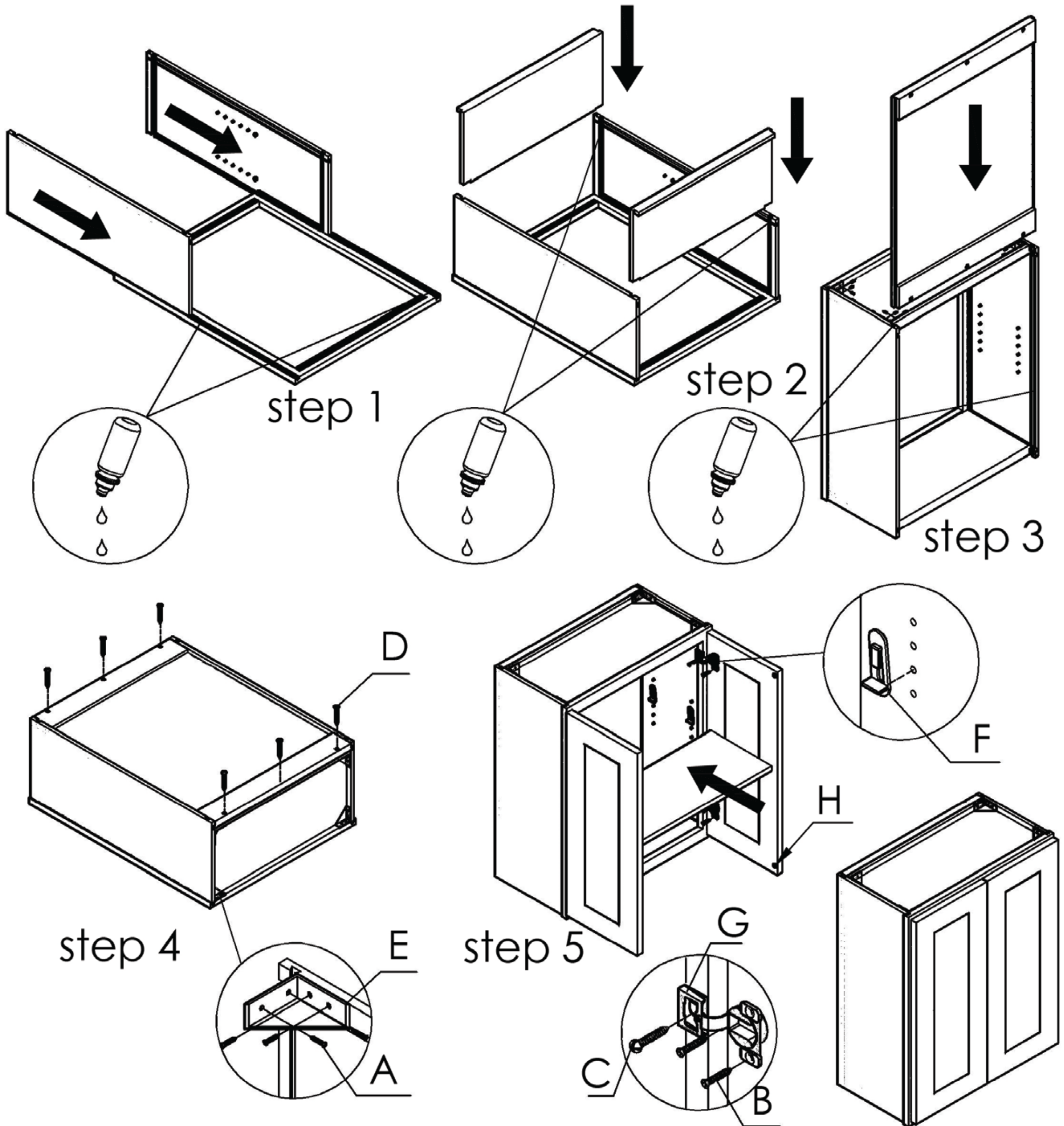

page 1 of 1

W2424-W3624

W332424-W362424

