







PART LIST

NO.	Picture	Specification	Qty
A		Screws $\text{Ø}3*1/2''$	56
B		Screws $\text{Ø}4*1''$	6
C		Shelf Clips	12
D		Metal Clip	14
E		Hinges	6
F		Screws $\text{Ø}4*3/4''$	6
G		Screws $\text{Ø}4*5/8''$	12





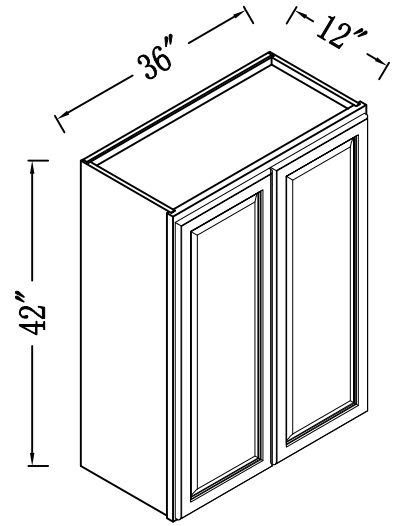

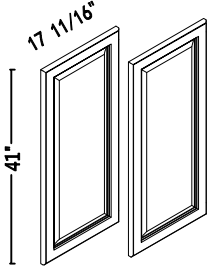
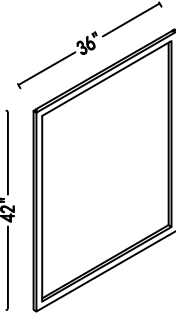
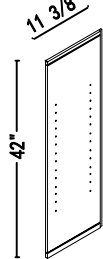
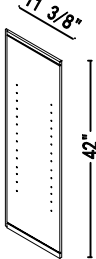
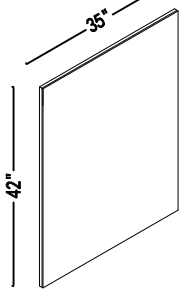
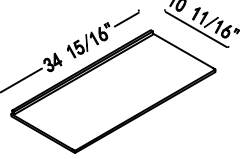
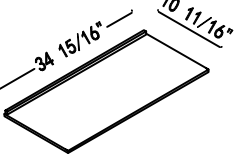
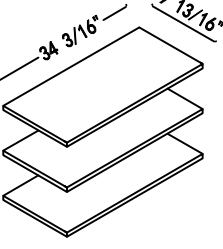

W3642

WM3642GDFI

Unit: inch

<p>1</p>  <p>Door</p>	<p>2</p>  <p>Face frame</p>	<p>3</p>  <p>Left Side Panel</p>	<p>4</p>  <p>Right Side Panel</p>	<p>5</p>  <p>Back board</p>
<p>6</p>  <p>Top Panel</p>	<p>7</p>  <p>Bottom Panel</p>	 <p>Shelf</p>		

Assembly instructions

NO.	PICTURE	SIZE	QTY	NO.	PICTURE	SIZE	QTY
A		Screws $\varnothing 3 \times 1/2$ "	56	E		Hinges	6
B		Screws $\varnothing 4 \times 1$ "	6	F		Screws $\varnothing 4 \times 3/4$ "	6
C		Shelf Clip	12	G		Screws $\varnothing 4 \times 5/8$ "	12
D		Metal Clip	14				

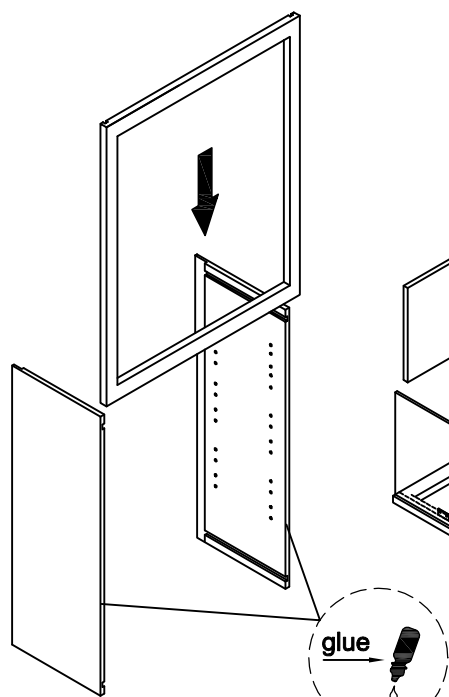

step 1

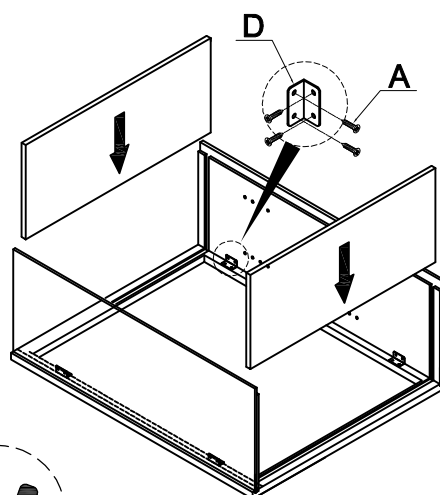

step 2

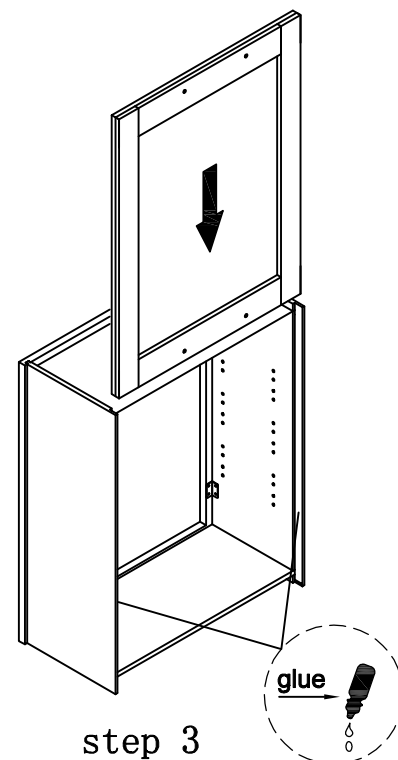

step 3

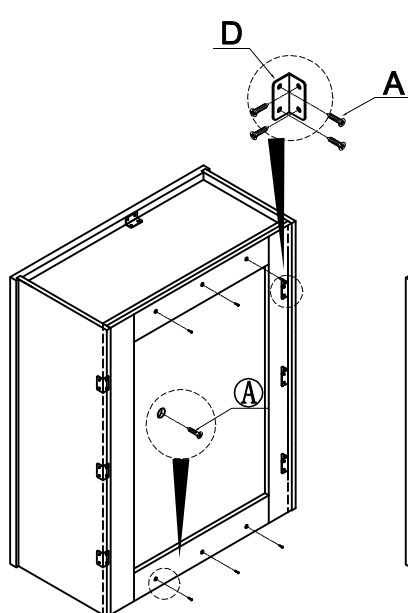

step 4

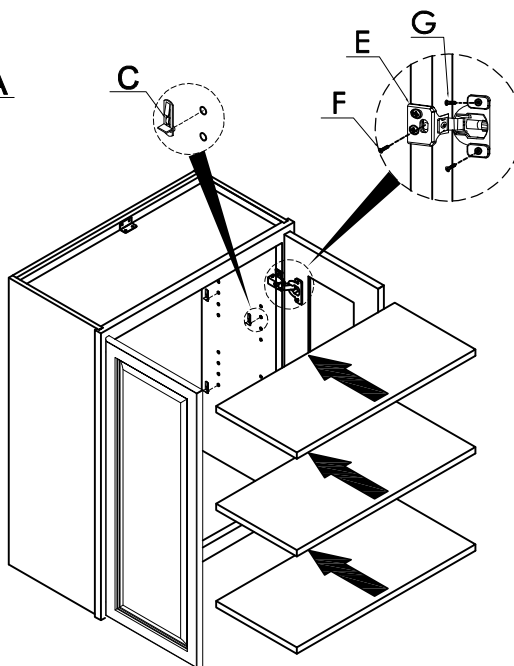

step 5

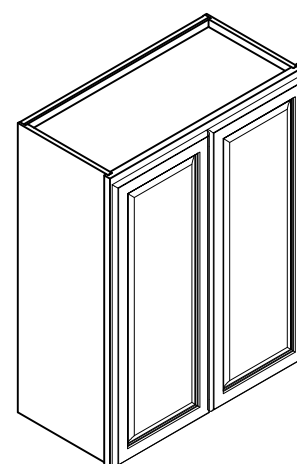

step 6