









# Part List

# DB30-3



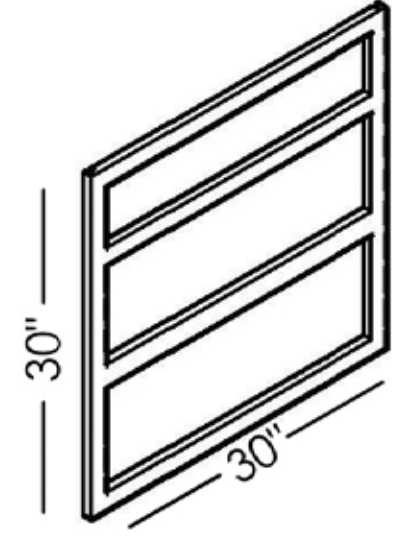
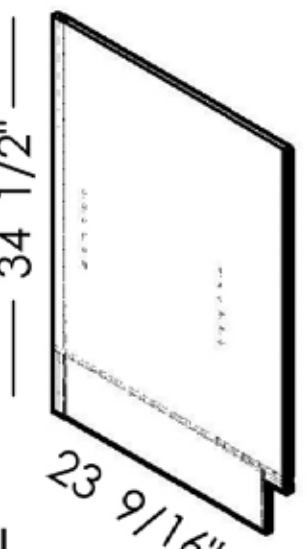
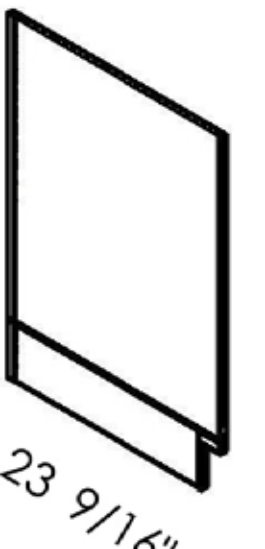
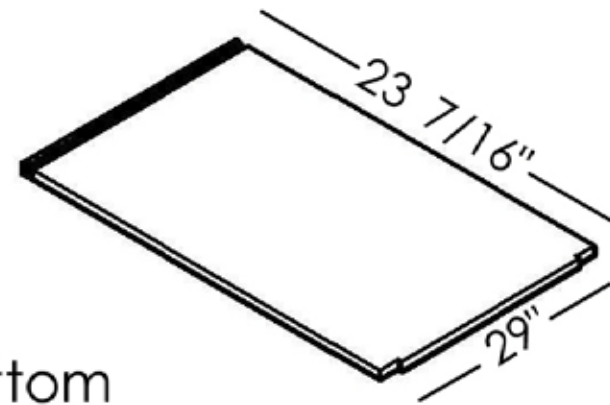

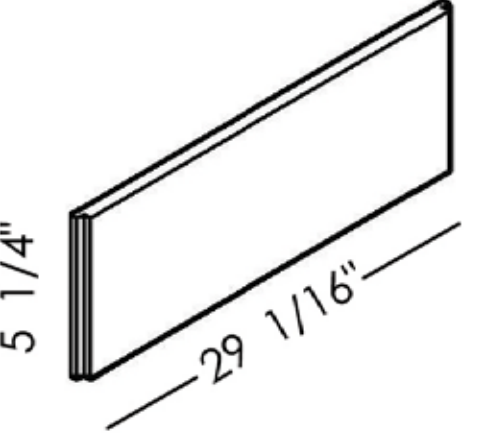
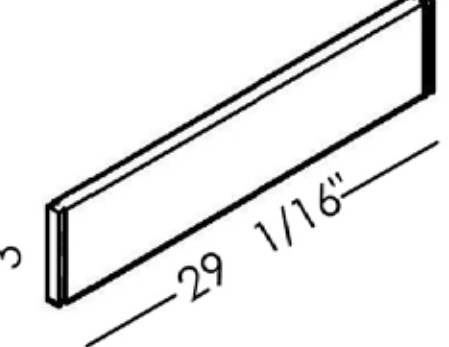
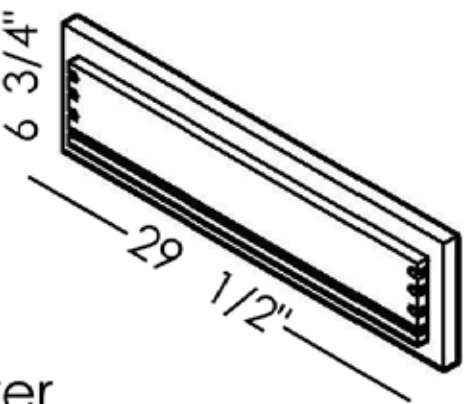
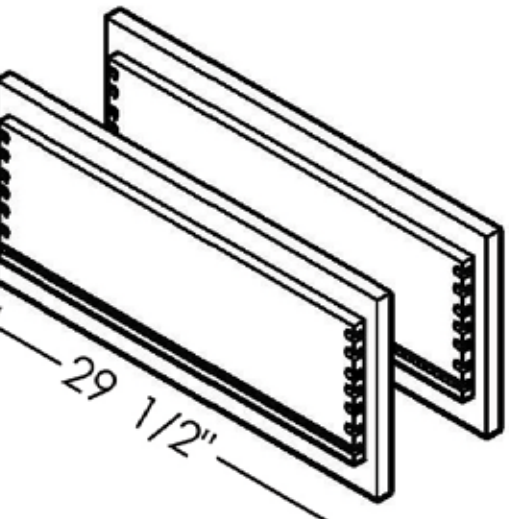
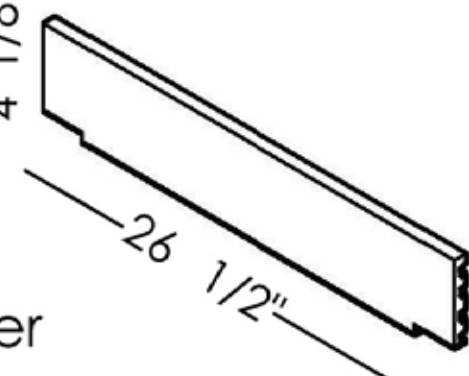
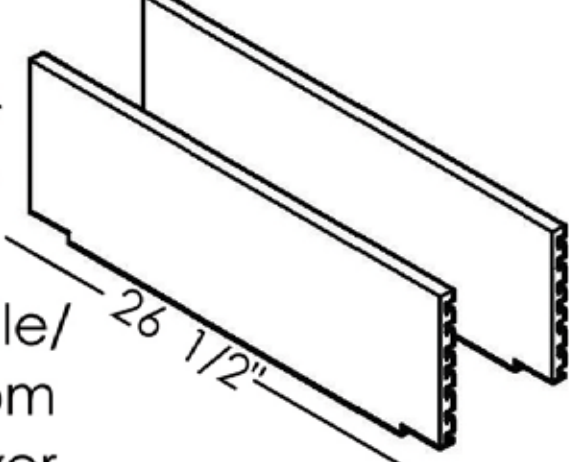
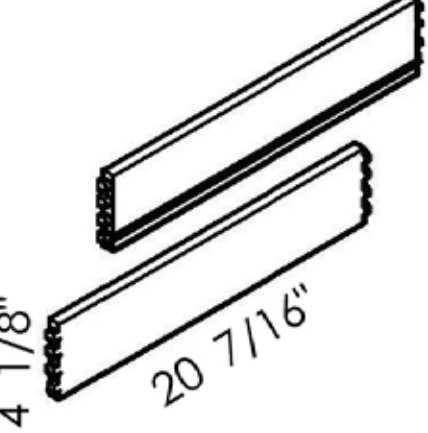
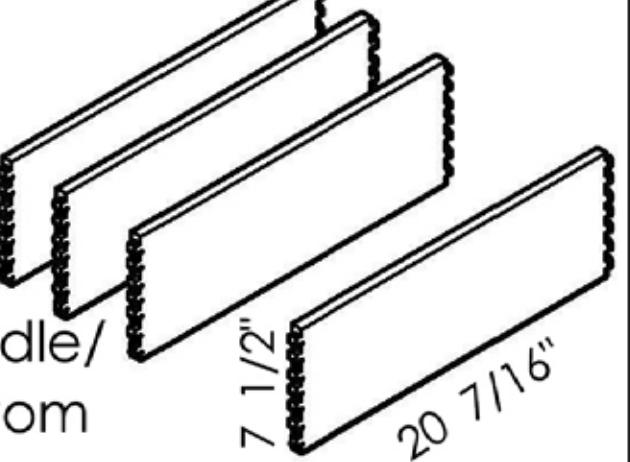
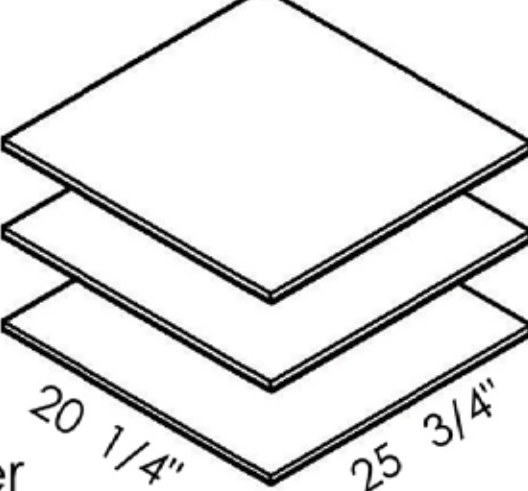

Unit: inch

No	Picture	Specification	Qty
A		Screw $\varnothing 3 \times 1/2$ "	62
B		L Bracket	6
C		Drawer Glides	6
D		Glide Connector	6
E		Corner Bracket	4
F		Metal Clip	4
G		Bumper	12

1  Face Frame	2  Left Side Panel	3  Right Side Panel
4  Bottom Panel	5  Back Panel	6  Front Toe kick
7  Back Toe kick	8  Top Drawer Front	9  Middle/Bottom Drawer Front
12  Drawer Back	13  Middle/Bottom Drawer Back	10  Top Drawer Sides
		11  Middle/Bottom Drawer Sides
	14  Drawer Bottom	



# Assembly instructions

No	Picture	Specification	Qty	No	Picture	Specification	Qty
A		Screw $\varnothing 3 \times 1/2''$	62	E		Corner Bracket	4
B		L Bracket	6	F		Metal Clip	4
C		Drawer Glides	6	G		Bumper	12
D		Glide Connector	6				

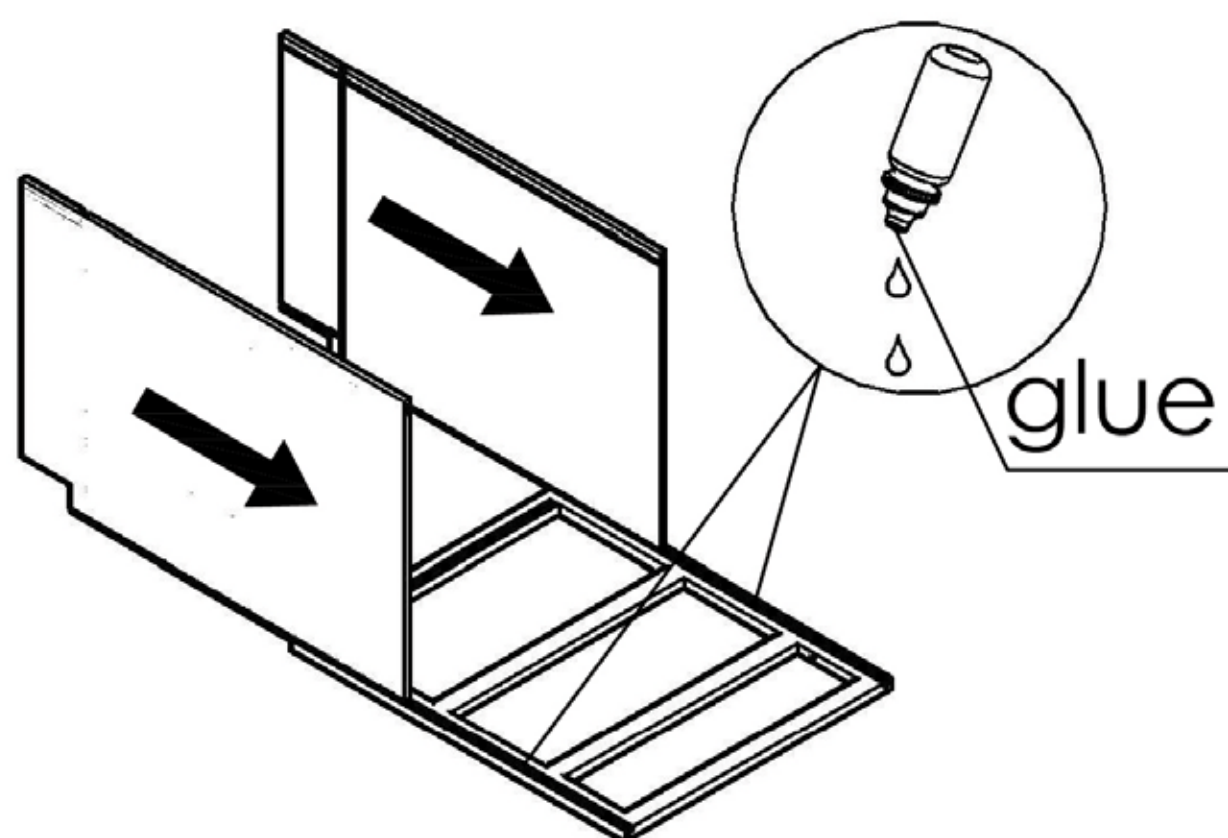

step 1

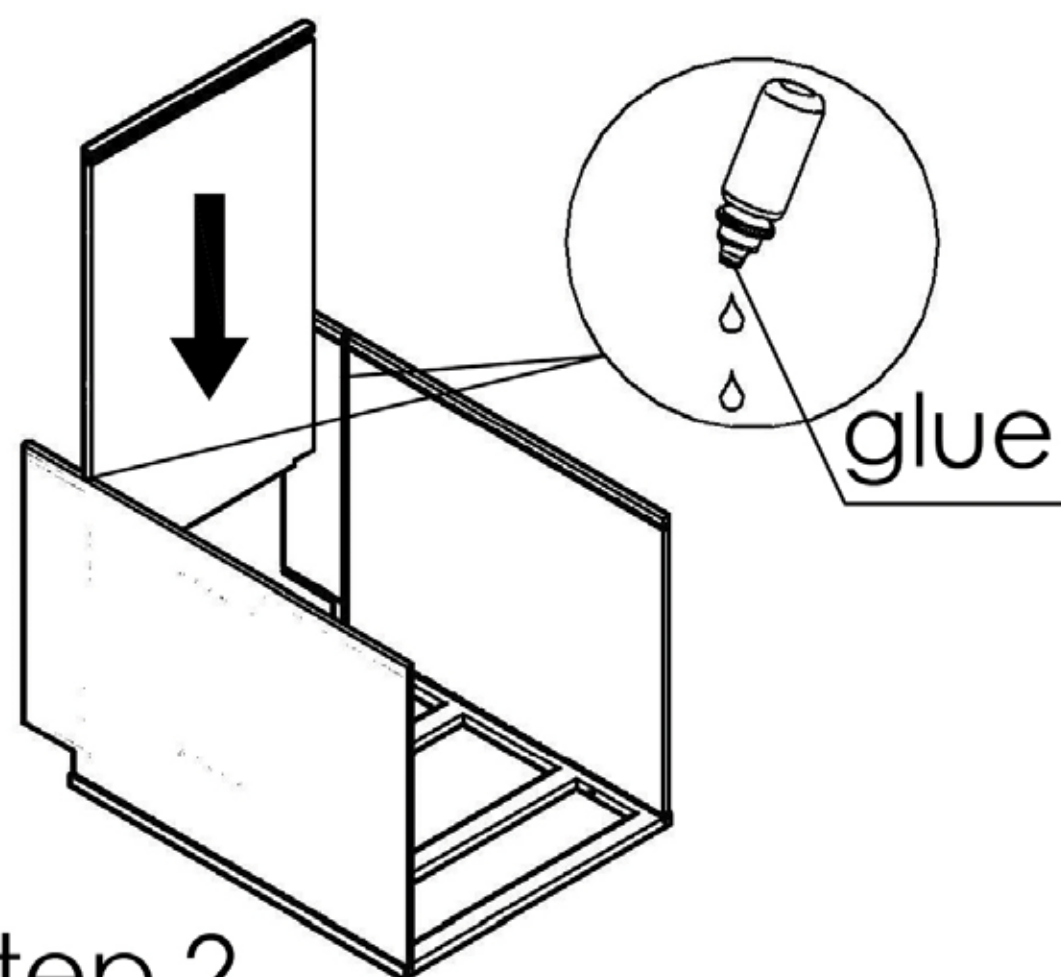

step 2

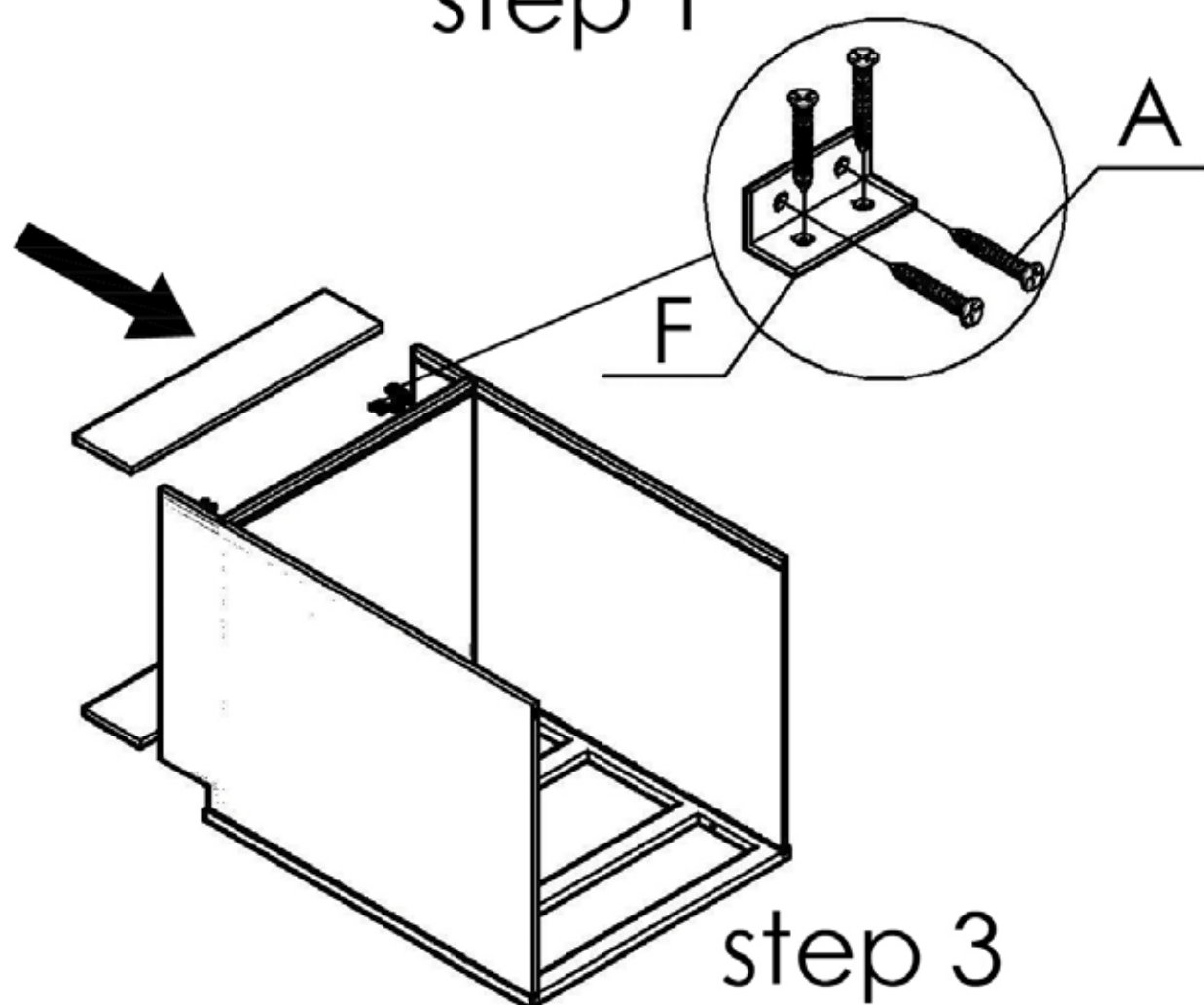

step 3

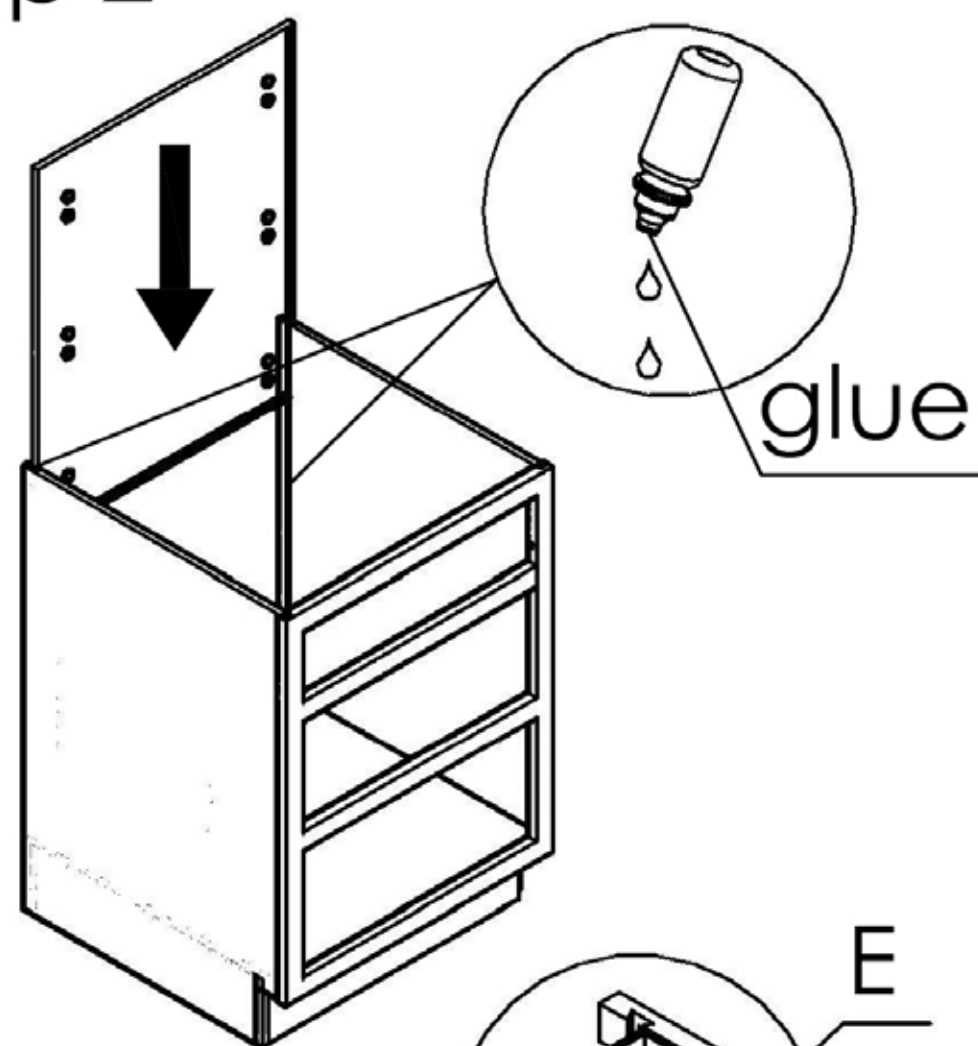

step 4

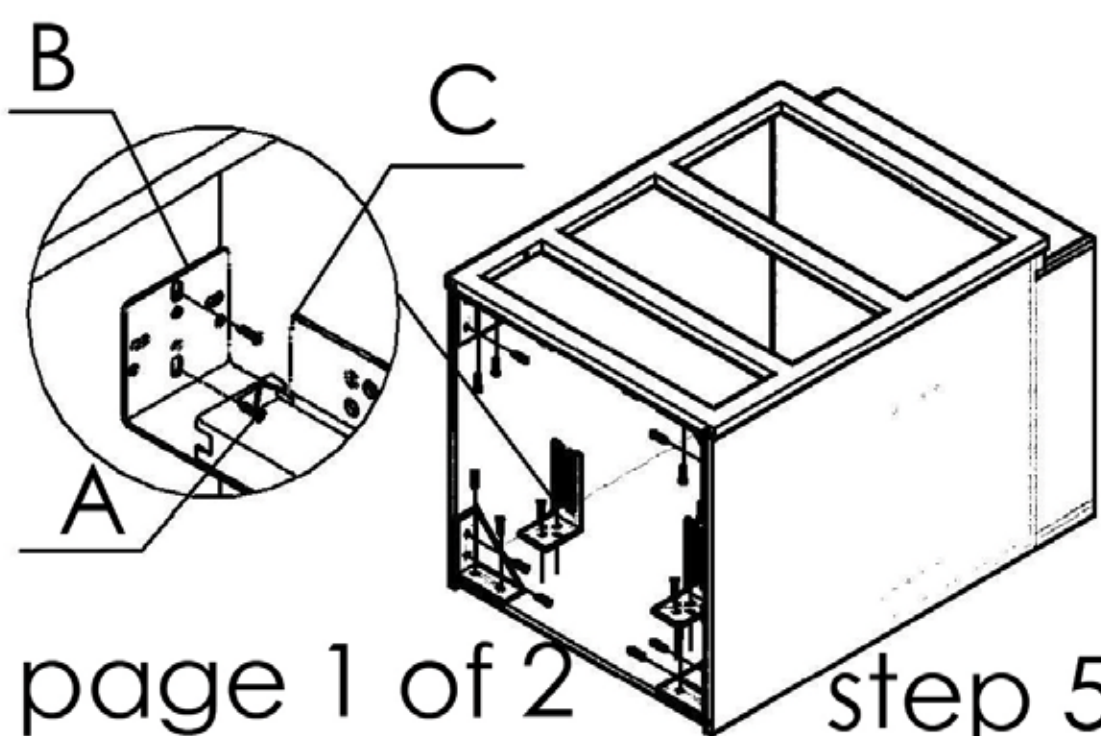

step 5

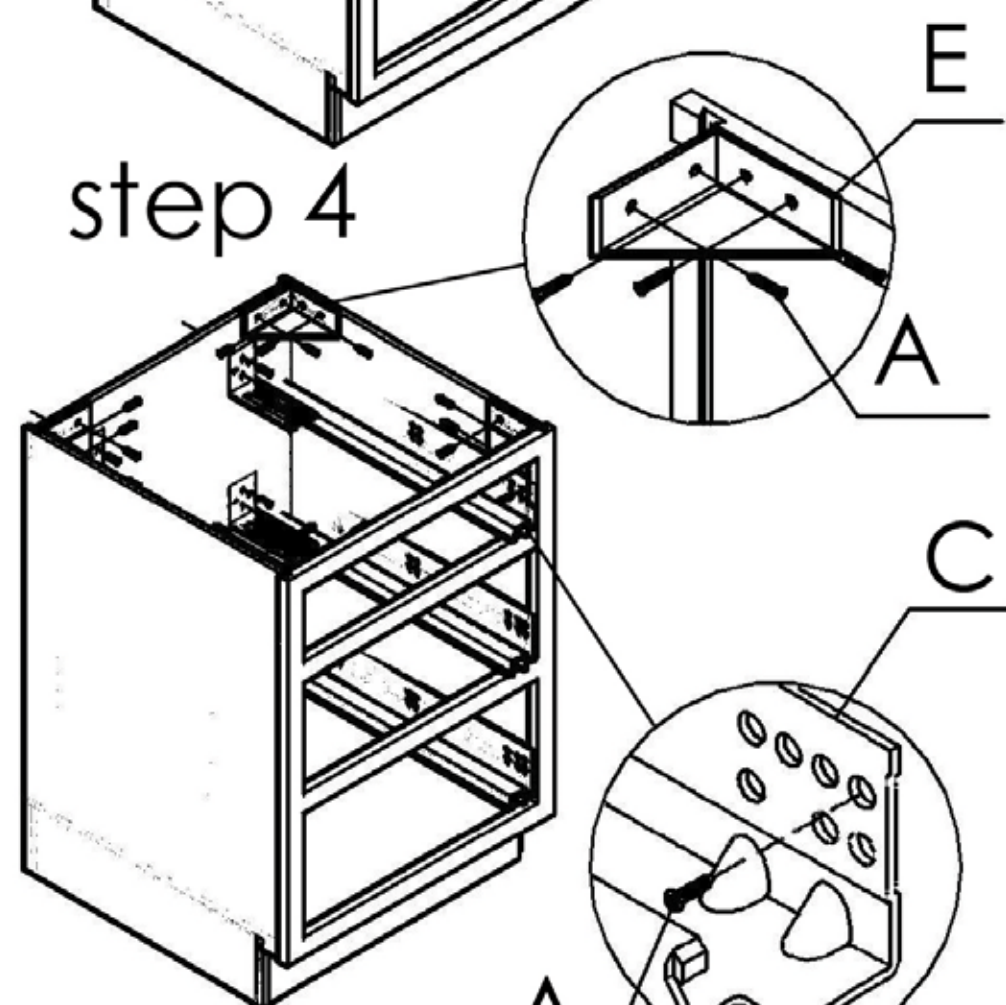

step 6



