











Part List





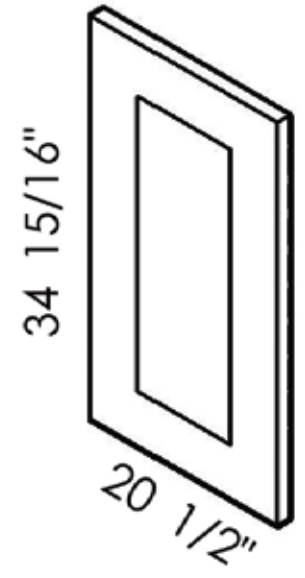
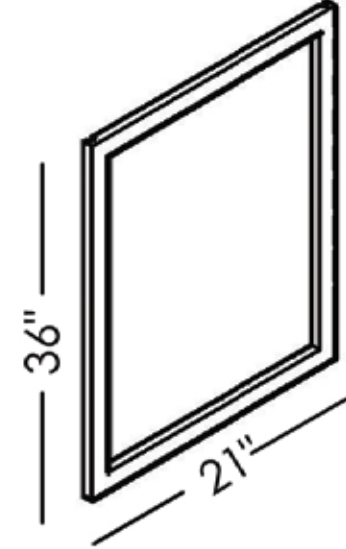

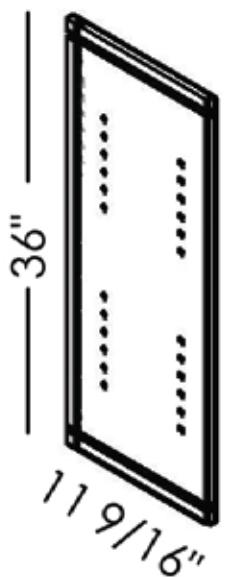
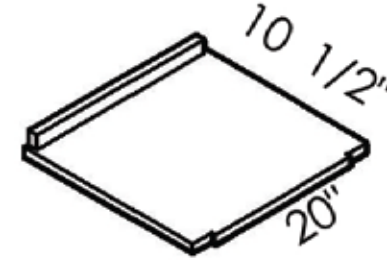
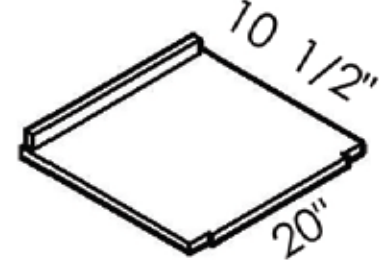
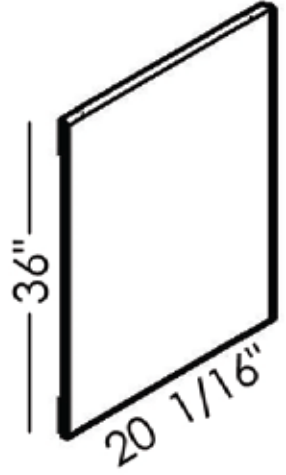
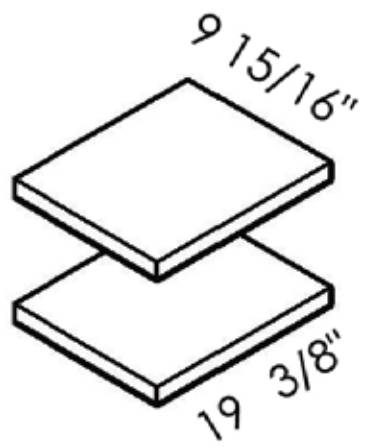
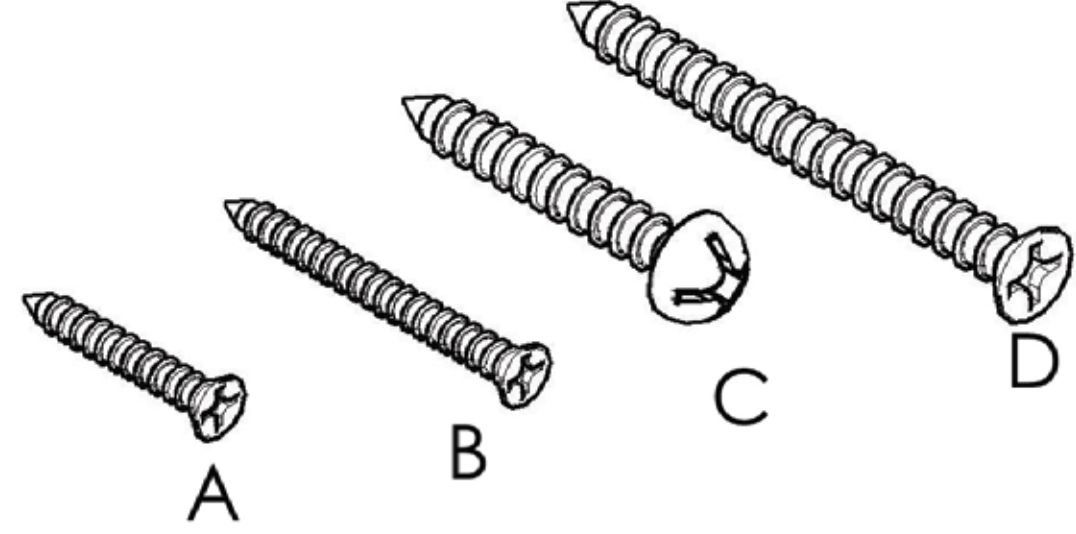

W2136 WM2136GDFI WOF2136GDFI

Unit: inch

No	Picture	Specification	Qty
A		Screw $\text{Ø}3 \times 1/2$ "	32
B		Screw $\text{Ø}3 \times 5/8$ "	4
C		Screw $\text{Ø}4 \times 5/8$ "	2
D		Screw $\text{Ø}4 \times 1 \frac{3}{16}$ "	4
E		Corner Bracket	8
F		Shelf Clip	8
G		Hinges	2
H		Bumper	2

<p>1</p>  <p>Door</p>	<p>2</p>  <p>Face Frame</p>	<p>3</p>  <p>Left Side Panel</p>
<p>4</p>  <p>Right Side Panel</p>	<p>5</p>  <p>Top Panel</p>	<p>6</p>  <p>Bottom Panel</p>
<p>7</p>  <p>Back Panel</p>	<p>8</p>  <p>Shelf</p>	
	 <p>A B C D</p>	

Assembly instructions

No	Picture	Specification	Qty	No	Picture	Specification	Qty
A		Screw $\varnothing 3 \times 1/2$ "	32	E		Corner Bracket	8
B		Screw $\varnothing 3 \times 5/8$ "	4	F		Shelf Clip	8
C		Screw $\varnothing 4 \times 5/8$ "	2	G		Hinges	2
D		Screw $\varnothing 4 \times 1 \frac{3}{16}$ "	4	H		Bumper	2

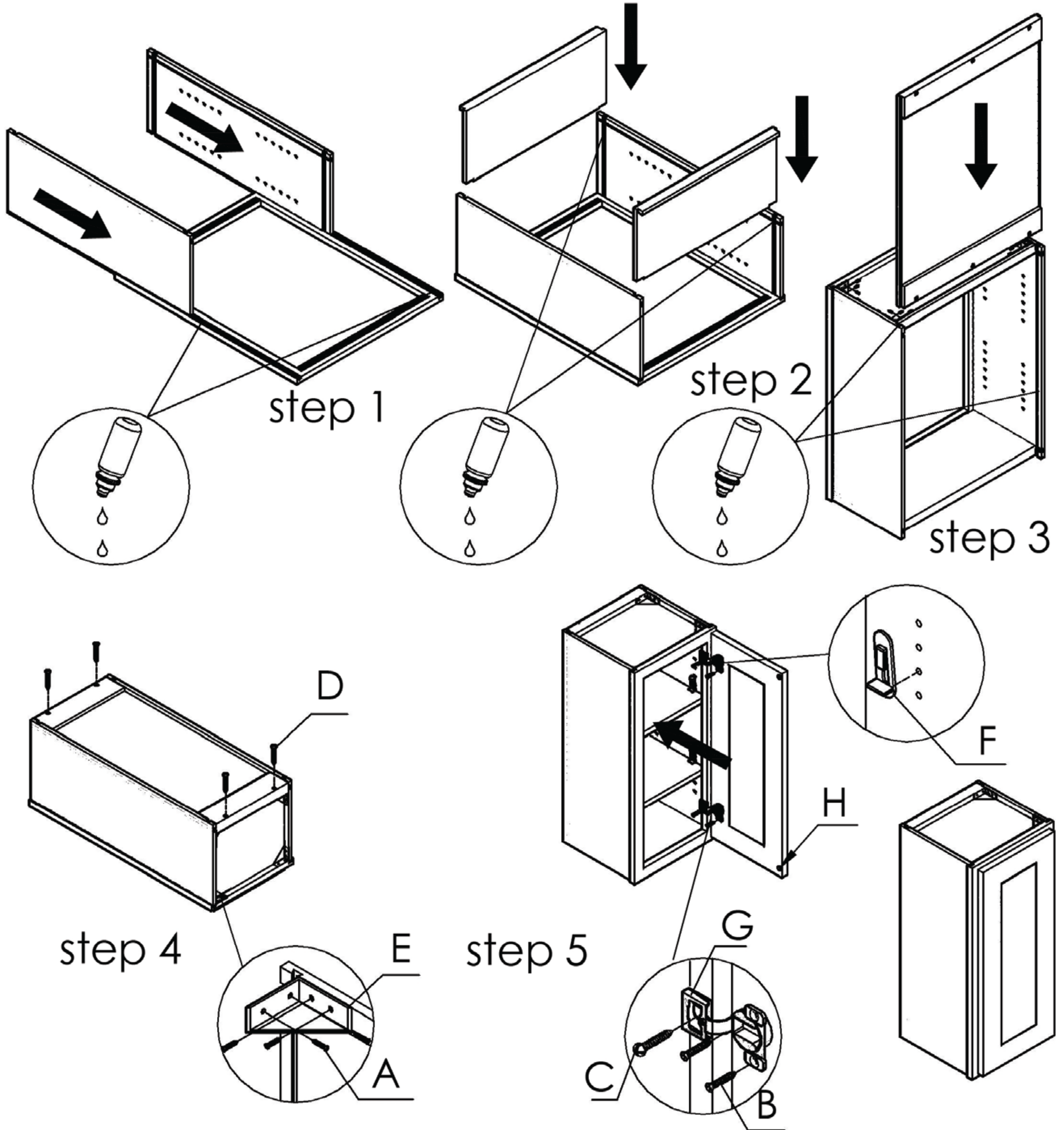

page 1 of 1

W0930-W2136

WM0930GDFI-WM2136GDFI

WOF0930GDFI-WOF2136GDFI

