









Part List





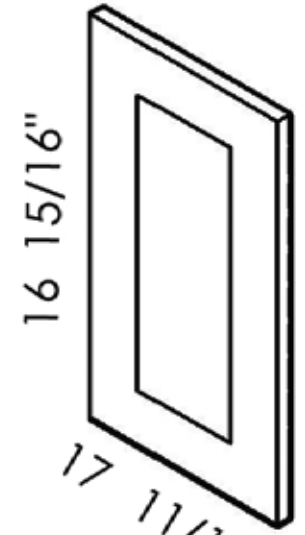
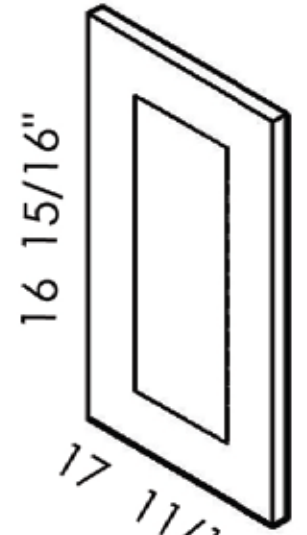
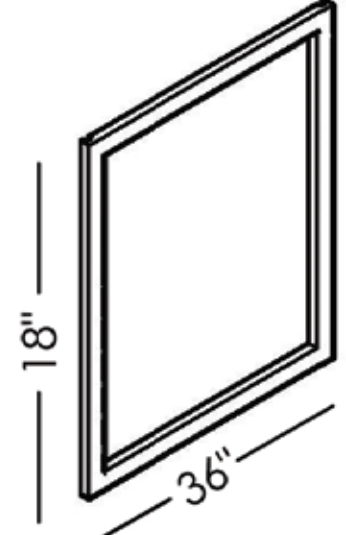
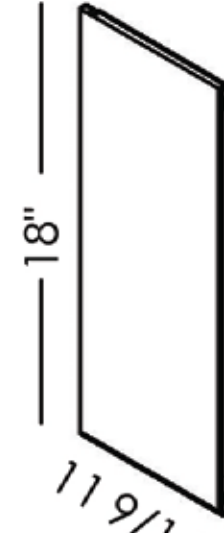

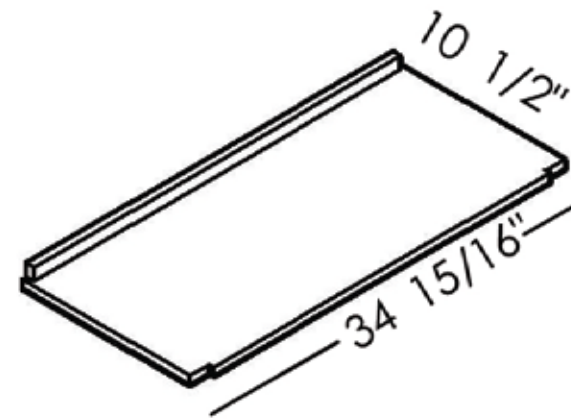
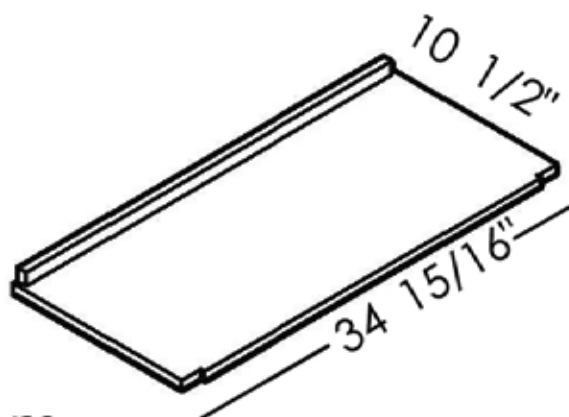
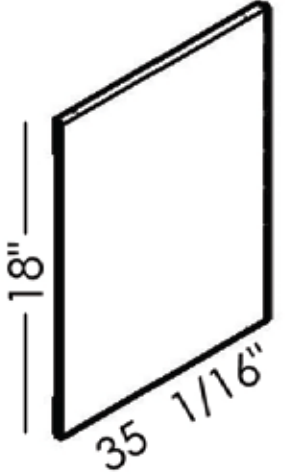
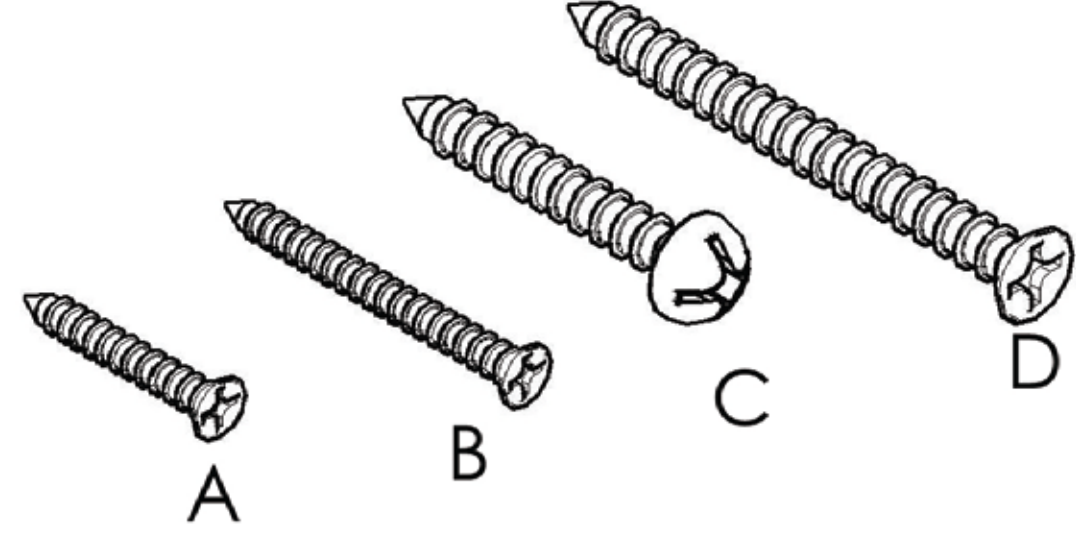
W3618

Unit: inch

No	Picture	Specification	Qty
A		Screw $\text{Ø}3 \times 1/2$ "	32
B		Screw $\text{Ø}3 \times 5/8$ "	8
C		Screw $\text{Ø}4 \times 5/8$ "	4
D		Screw $\text{Ø}4 \times 1 \frac{3}{16}$ "	6
E		Corner Bracket	8
F		Hinges	4
G		Bumper	4

<p>1</p>  <p>Left Door</p>	<p>2</p>  <p>Right Door</p>	<p>3</p>  <p>Face Frame</p>
<p>4</p>  <p>Left Side Panel</p>	<p>5</p>  <p>Right Side Panel</p>	<p>6</p>  <p>Top Panel</p>
<p>7</p>  <p>Bottom Panel</p>	<p>8</p>  <p>Back Panel</p>	
		 <p>A B C D</p>

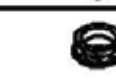
Assembly instructions

No	Picture	Specification	Qty	No	Picture	Specification	Qty
A		Screw $\varnothing 3 \times 1/2$ "	32	E		Corner Bracket	8
B		Screw $\varnothing 3 \times 5/8$ "	8	F		Hinges	4
C		Screw $\varnothing 4 \times 5/8$ "	4	G		Bumper	4
D		Screw $\varnothing 4 \times 1 \frac{3}{16}$ "	6				

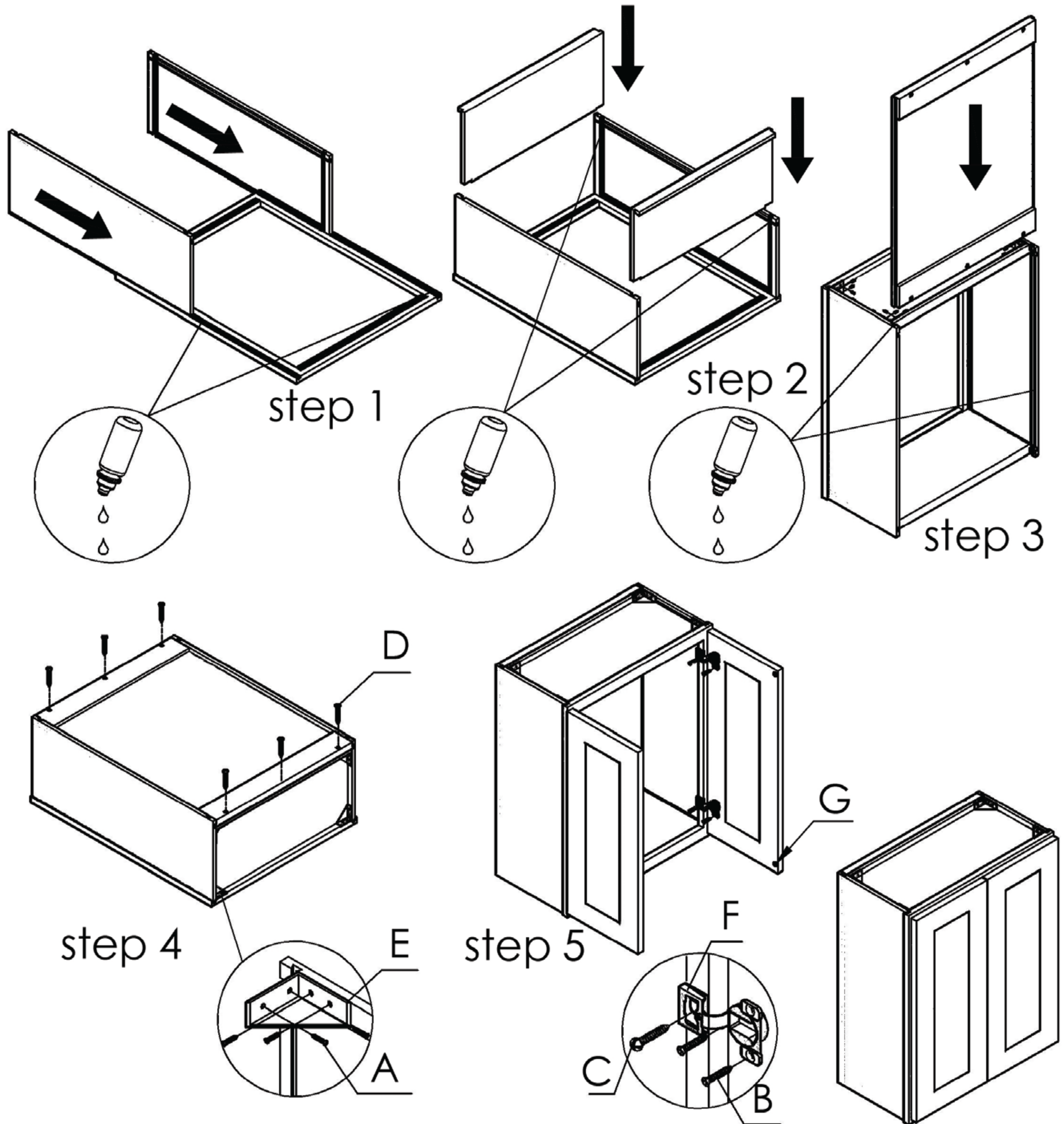

page 1 of 1

W2412-W3612 W331224-W361224

W2415-W3615 W331524-W361524

W2418-W3618 W331824-W361824

