









# Part List

W0942 WM0942GDFI WOF0942GDFI





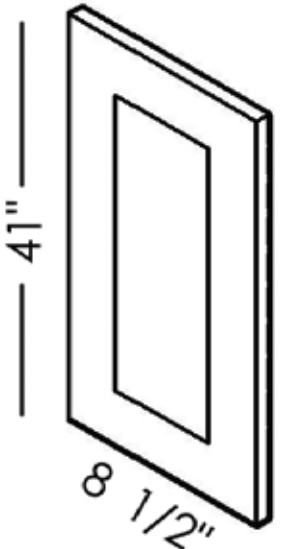
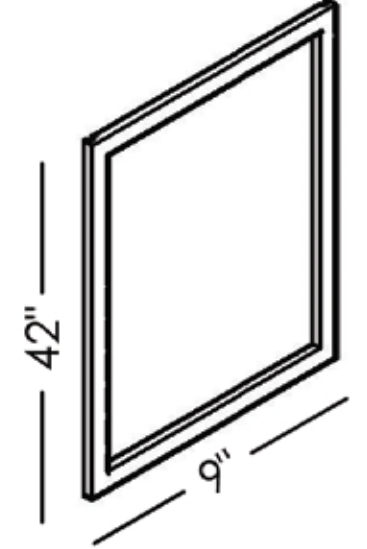
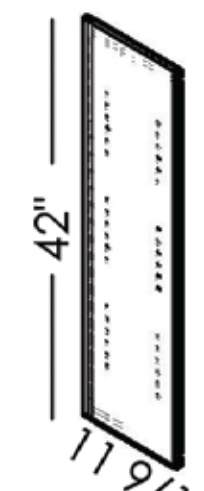
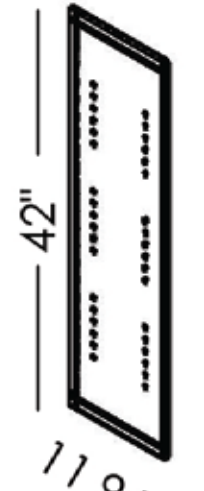
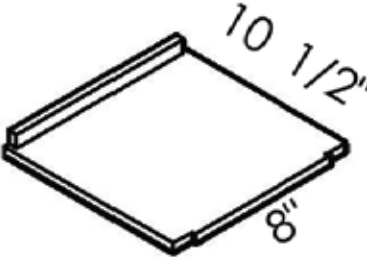
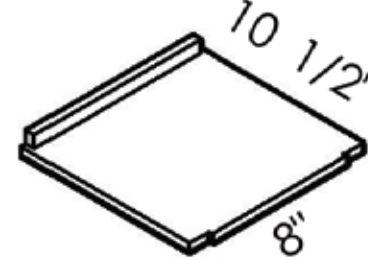
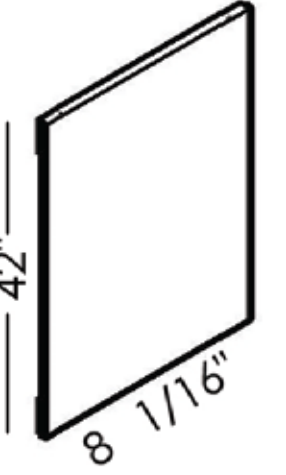
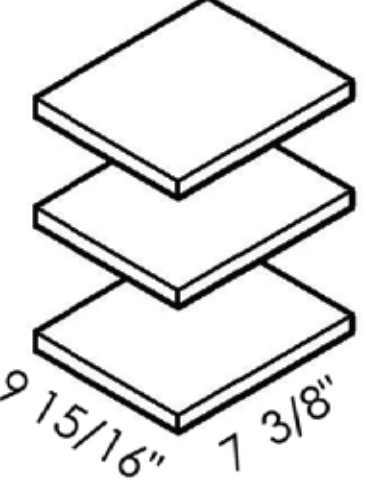
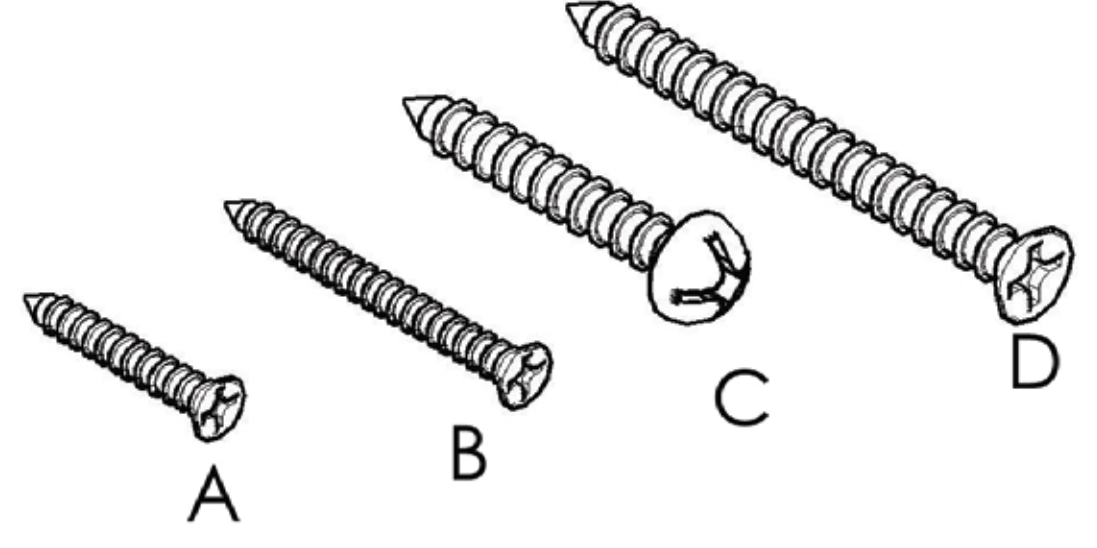



Unit: inch

No	Picture	Specification	Qty
A		Screw $\text{Ø}3 \times 1/2$ "	32
B		Screw $\text{Ø}3 \times 5/8$ "	6
C		Screw $\text{Ø}4 \times 5/8$ "	3
D		Screw $\text{Ø}4 \times 1 \frac{3}{16}$ "	4
E		Corner Bracket	8
F		Shelf Clip	12
G		Hinges	3
H		Bumper	2

<p>1</p>  <p>Door</p>	<p>2</p>  <p>Face Frame</p>	<p>3</p>  <p>Left Side Panel</p>
<p>4</p>  <p>Right Side Panel</p>	<p>5</p>  <p>Top Panel</p>	<p>6</p>  <p>Bottom Panel</p>
<p>7</p>  <p>Back Panel</p>	<p>8</p>  <p>Shelf</p>	
	 <p>A B C D</p>	



# Assembly instructions

No	Picture	Specification	Qty	No	Picture	Specification	Qty
A		Screw $\varnothing 3 \times 1/2$ "	32	E		Corner Bracket	8
B		Screw $\varnothing 3 \times 5/8$ "	6	F		Shelf Clip	12
C		Screw $\varnothing 4 \times 5/8$ "	3	G		Hinges	3
D		Screw $\varnothing 4 \times 1 \frac{3}{16}$ "	4	H		Bumper	2

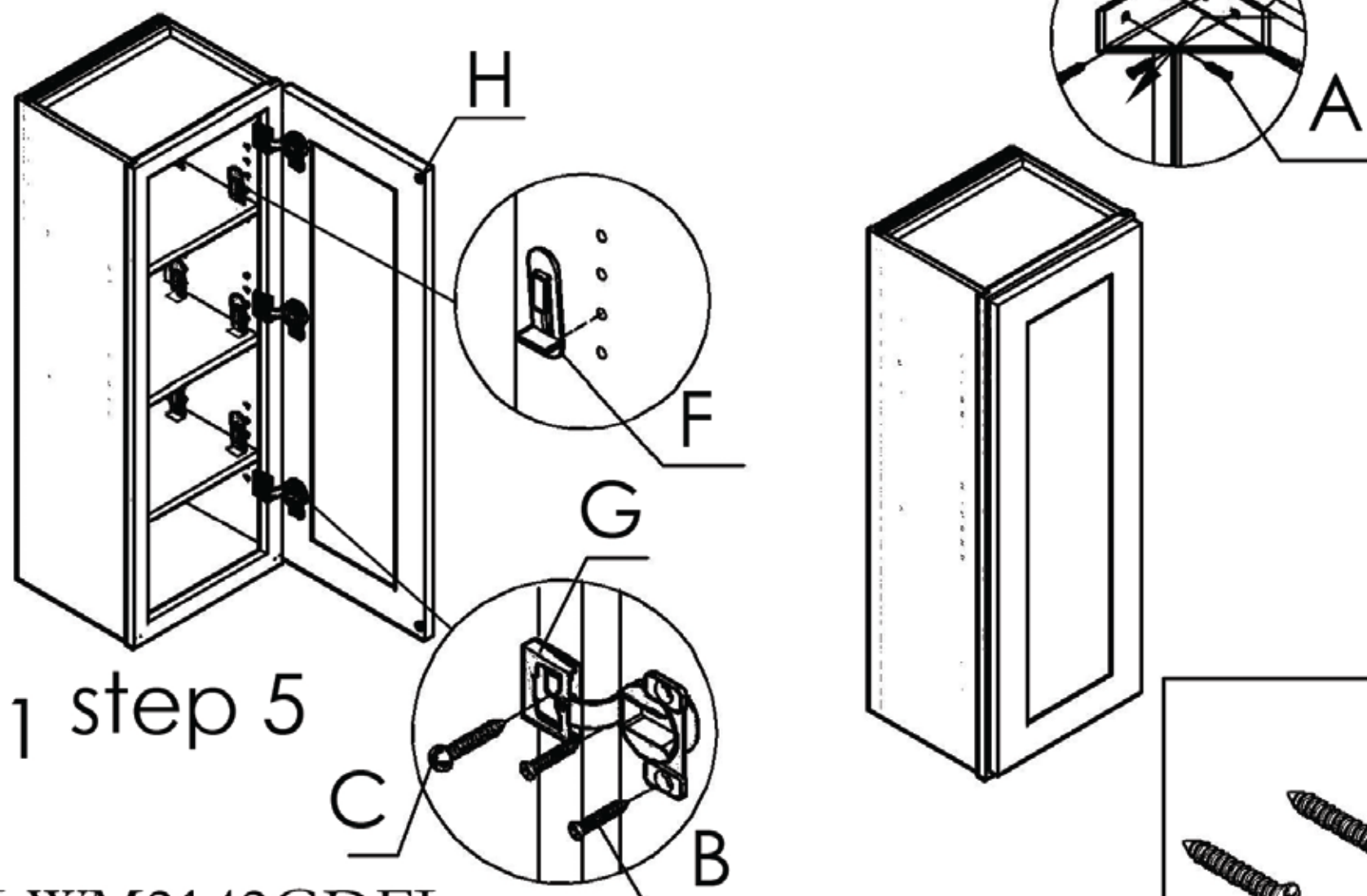
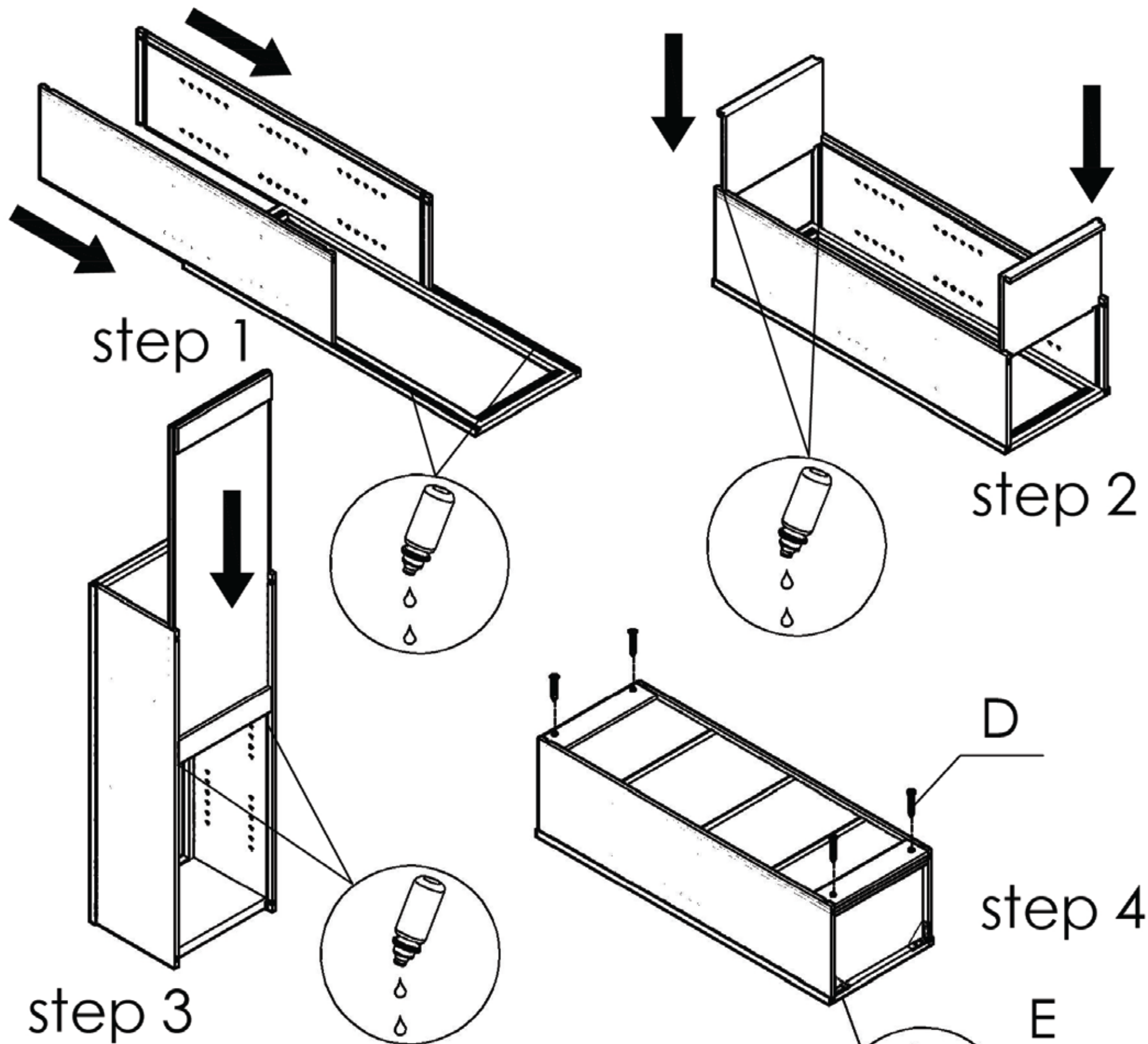

page 1 of 1 step 5

W0942-W2142

WM0942GDFI-WM2142GDFI

WOF0942GDFI-WOF2142GDFI

