









Part List

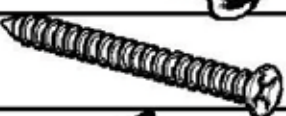



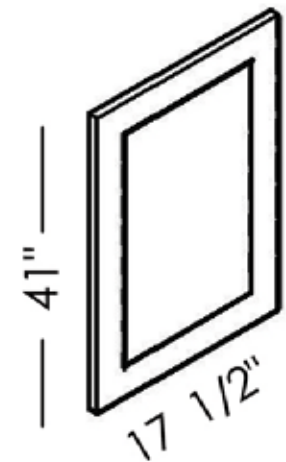
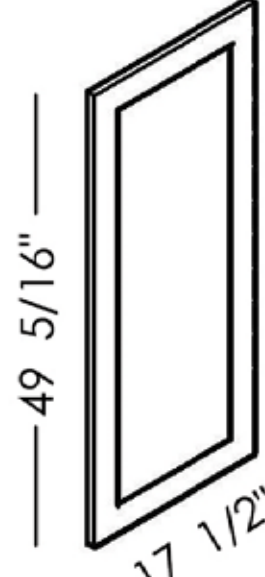

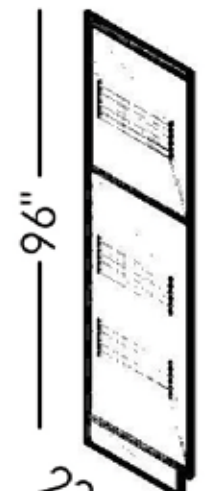
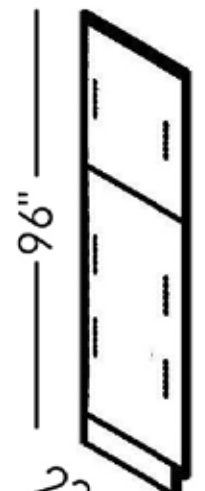
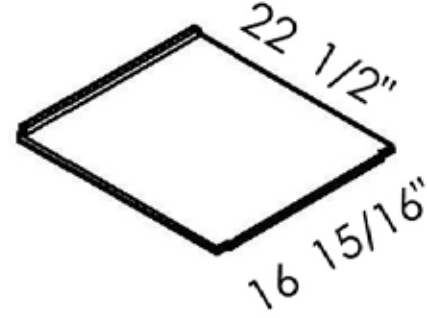
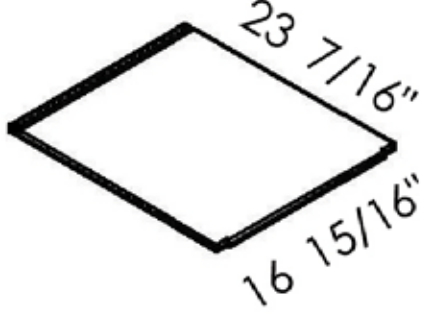
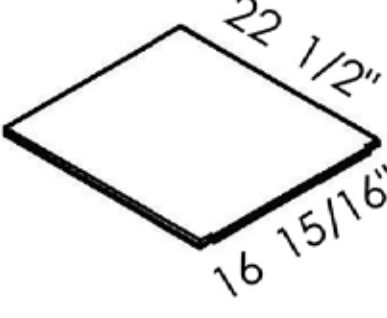
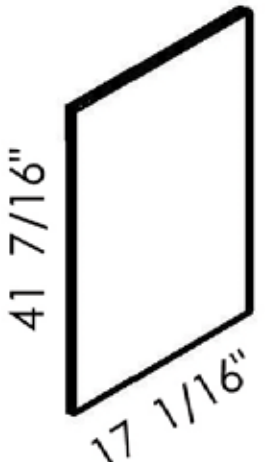
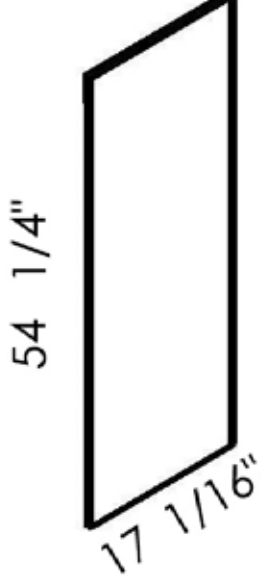
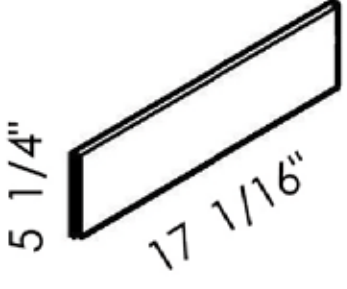
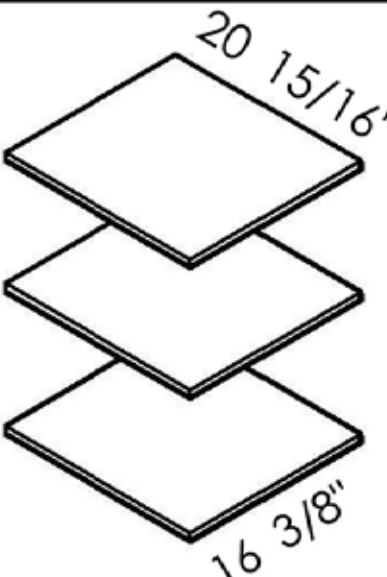
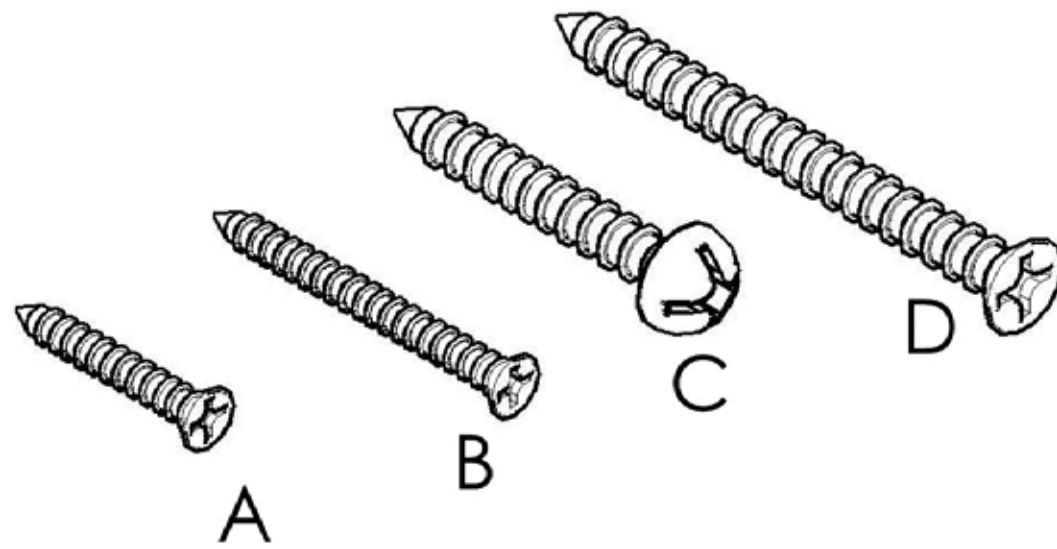

U189624

Unit: inch

| No | Picture | Specification | Qty |
|----|---|---|-----|
| A |  | Screw $\text{Ø}3 \times 1/2$ " | 32 |
| B |  | Screw $\text{Ø}3 \times 5/8$ " | 10 |
| C |  | Screw $\text{Ø}4 \times 5/8$ " | 5 |
| D |  | Screw $\text{Ø}4 \times 1 \frac{3}{16}$ " | 3 |
| E |  | Metal Clip | 4 |
| F |  | Hinges | 5 |
| G |  | Bumper | 4 |
| H |  | Shelf Clip | 12 |
| | | | |
| | | | |
| | | | |

| | | |
|--|---|--|
| <p>1</p>  <p>Top Door</p> | <p>2</p>  <p>Bottom Door</p> | <p>3</p>  <p>Face Frame</p> |
| <p>4</p>  <p>Left Side Panel</p> | <p>5</p>  <p>Right Side Panel</p> | <p>6</p>  <p>Top Panel</p> |
| <p>7</p>  <p>Middle Bottom Panel</p> | <p>8</p>  <p>Bottom Panel</p> | <p>9</p>  <p>Top Back Panel</p> |
| <p>10</p>  <p>Bottom Back Panel</p> | <p>11</p>  <p>Front Toe kick</p> | <p>12</p>  <p>Shelf</p> |
|  | | |

Assembly instructions

| No | Picture | Specification | Qty | No | Picture | Specification | Qty |
|----|---|---|-----|----|---|---------------|-----|
| A |  | Screw $\varnothing 3 \times 1/2$ " | 32 | E |  | Metal Clip | 4 |
| B |  | Screw $\varnothing 3 \times 5/8$ " | 10 | F |  | Hinges | 5 |
| C |  | Screw $\varnothing 4 \times 5/8$ " | 5 | G |  | Bumper | 4 |
| D |  | Screw $\varnothing 4 \times 1 \frac{3}{16}$ " | 3 | H |  | Shelf Clip | 12 |
| | | | | | | | |
| | | | | | | | |

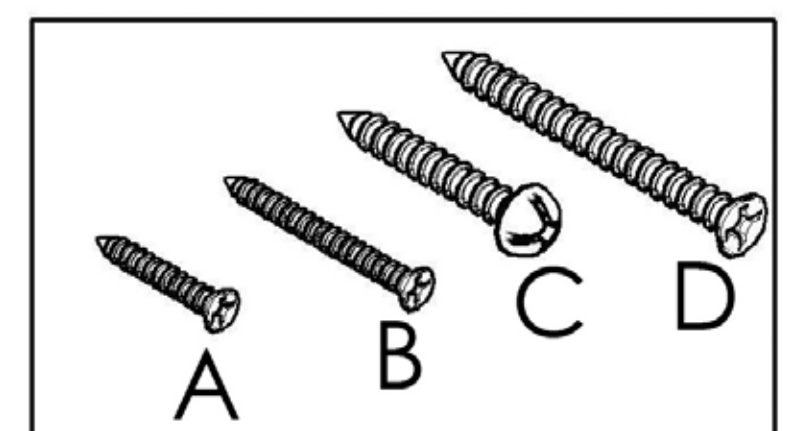
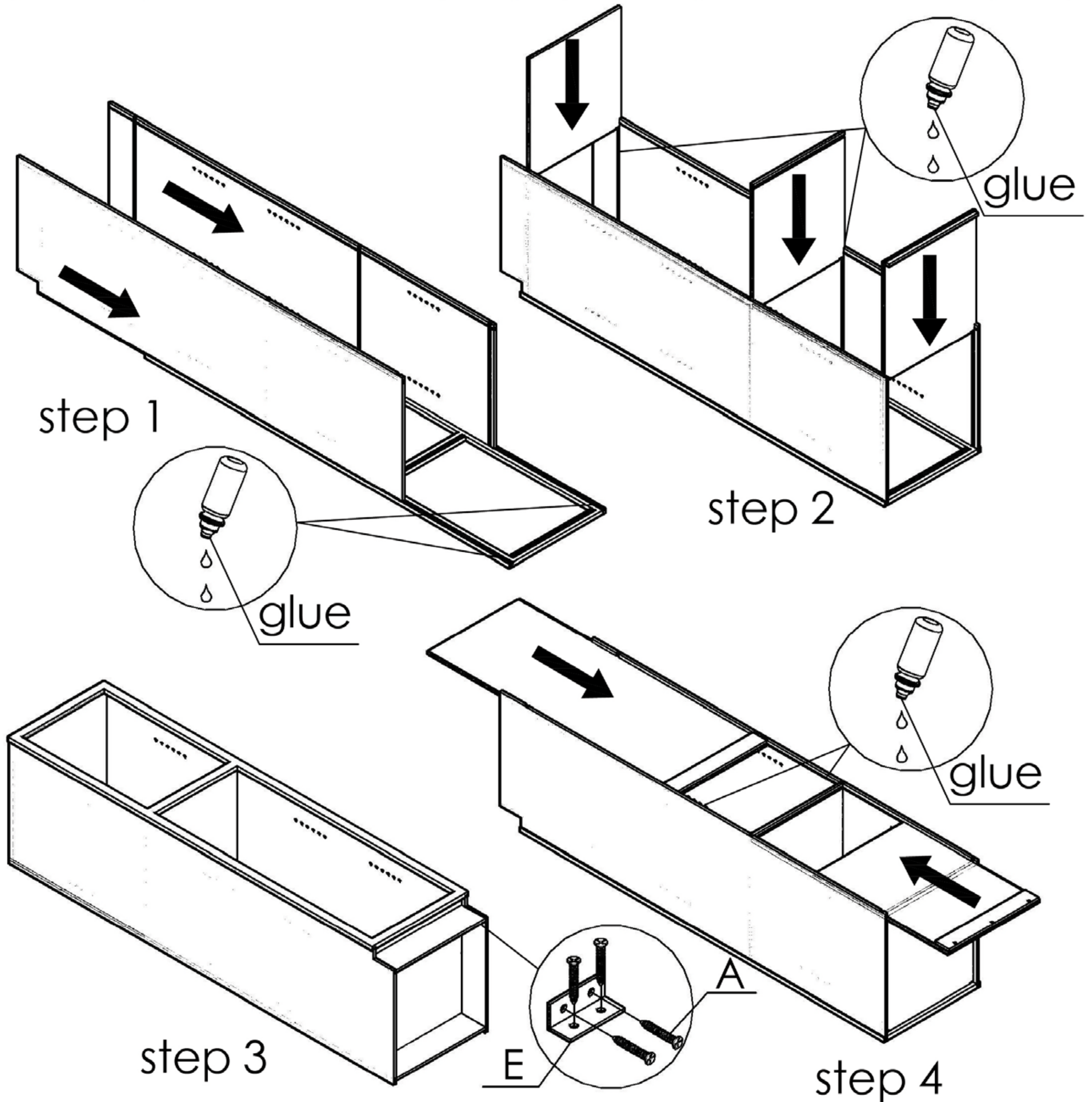

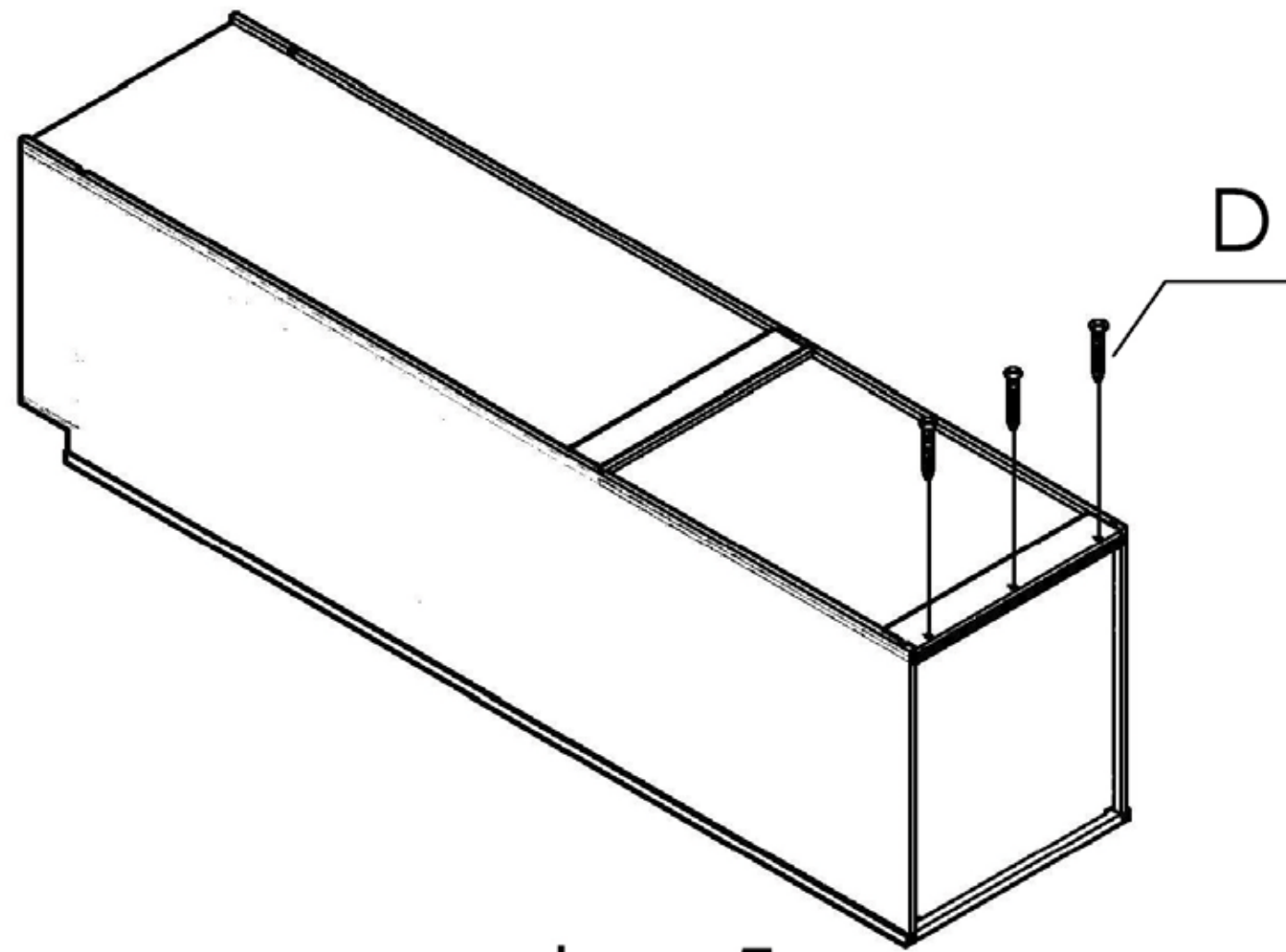

step 5

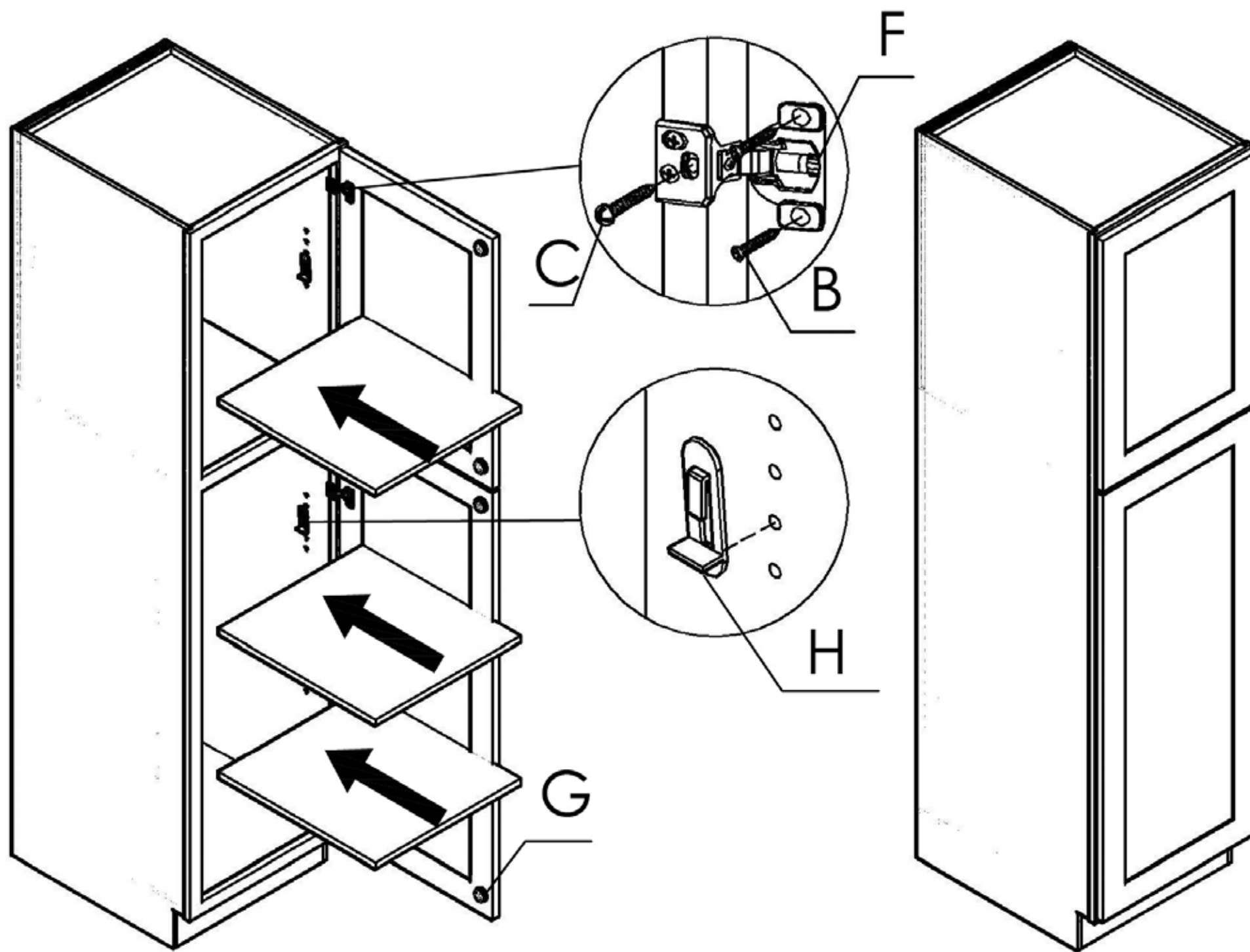

step 6

page 2 of 2
(U188424
U189024
U189624)

